

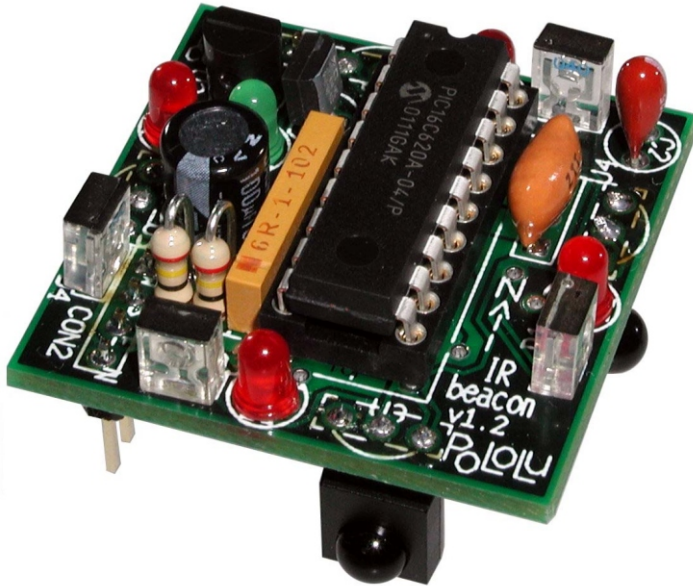

IR Beacon

User's Guide



Contents:

- Safety Warning
- Contacting Pololu
- Parts List
- How to Solder
- Assembly Instructions
- Mounting and Connecting the Beacon
- Testing Your Beacon
- How the Beacon Works
- Troubleshooting Tips
- Description and Specifications





Important Safety Warning

This kit is not intended for young children! Assembly of this kit requires high-temperature soldering and the use of sharp cutting tools. Some included components may become hot, leak, or explode if used improperly. Pololu strongly recommends that you wear safety glasses when building or working with *any* electronic equipment. Children should use this kit only under adult supervision. **By using this product, you agree not to hold Pololu liable for any injury or damage related to the use or to the performance of this product. This product is not designed for, and should not be used in, applications where the malfunction of the product could cause injury or damage.**

Contacting Pololu

You can check the Pololu web site at <http://www.pololu.com/> for latest information about the IR Beacon, including color pictures, application examples, and troubleshooting tips.

We would be delighted to hear from you about your project and about your experience with our IR Beacon. You can contact us through our online feedback form or by email at support@pololu.com. Tell us what we did well, what we could improve, what you would like to see in the future, or anything else you would like to say!



Parts List

The following components are the IR beacon kit parts. Make sure to verify that all components are included, and that you know which component is which. For each component, the reference number, description, and quantity are indicated. There are 25 parts in the kit, including the PCB.



C1
Electrolytic
Capacitor
x 1



C2
Tantalum
Capacitor
x 1

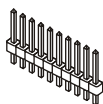

CON1, CON2
10-pin male
Header
x 1



D1-D4
Right-angle
IR LED
x 4



D5-D8
Red LED
x 4



D9
Green LED
x 1



Q1
N-channel
FET
x 1



R1, R2
¼ Watt
Resistor
x 2



RP1
6-pin
Resistor Pack
x 1

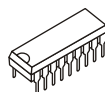

U1
18-pin PIC
Microcontroller
x 1

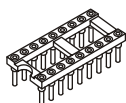

(U1)
18-pin Socket
for U1
x 1



U2
5-volt
Regulator
x 1



U3-U6
IR Detector
Module
x 4



X1
4 Mhz
Resonator
x 1



PCB
Printed
Circuit Board
x 1

How to Solder

You need a soldering iron and diagonal cutters to assemble the beacon. The green printed circuit board (PCB) is the base that holds the components together and establishes the necessary electrical connections. The PCB has two sides: a **TOP** side, or *component side*, which has white silkscreen markings, and a **BOTTOM** side, or *solder side*. Most components belong on the **TOP** side, but you must insert the IR detector modules (U3-U6) and the connectors (CON1, CON2) from the **BOTTOM** and solder on the top side. In general, you should insert and solder the components so that they are as close as possible to the PCB. After soldering, trim excess leads with diagonal cutters.

To solder, heat a component lead and the PCB pad and then apply solder until the solder flows onto both the lead and the pad. If the solder beads up on the lead or on the pad, the connection is bad, so you should apply more heat. However, be careful not to damage any components through overheating. A good connection should be nice and shiny.

1: solder

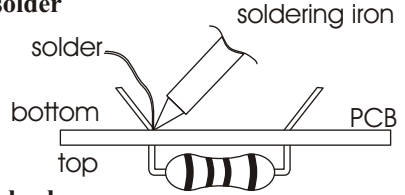

2: check

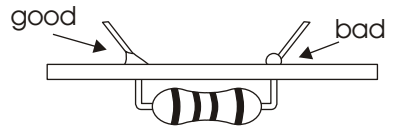

3: trim leads



Assembly Instructions

Caution: The components U1-U6 and Q1 can be damaged by static electricity. Ground yourself (touch a water pipe or the metal frame of a piece of electrical equipment) before handling these components, and avoid touching their leads. Once assembled, the beacon can be stored safely in the conductive bag in which the kit is packaged.

Note: Because the circuit board is densely populated with components on both sides, we strongly recommend that you carefully follow the provided order of assembly.

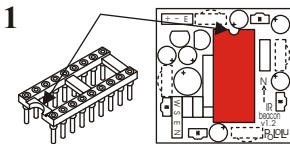

1 Insert the 18-pin socket from the **TOP** side of the PCB in the area indicated U1, and solder. **The socket has a notch on one side, which you should align with the notch on the PCB drawing.** The socket protects the PIC microcontroller, U1, from being damaged during soldering. The socket also allows U1 to be removed from the board to access the mounting holes, which are under U1.

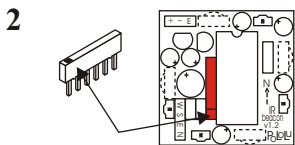

Insert the 6-pin resistor pack onto the **TOP** side of the PCB in the location for RP1. **The resistor pack has a mark on one side, which must be oriented toward the corresponding mark on the board.** The resistor pack contains current-limiting resistors for the red and green indicator LEDs.

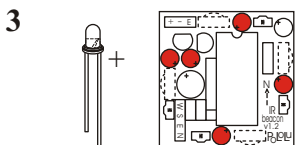

Next, add the visible LEDs, D5-D9, on the **TOP** side of the PCB. The four red LEDs are along the perimeter of the PCB, while the green LED D9 is further in. **LEDs are polarized, so you must insert them properly.** The longer lead must be on the side indicated by a '+' on the PCB silkscreen.

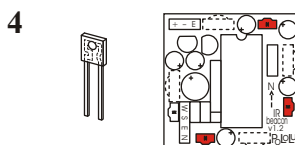

Add **three of four** infrared LEDs, D1-D3, from the **TOP** of the board. **The lens on the side of the package must face OUT from the center of the board.** When viewed face-on from any side of the PCB, the infrared LED on that side of the board should appear as indicated in the drawing to the right. **DO NOT MOUNT D4 YET!**

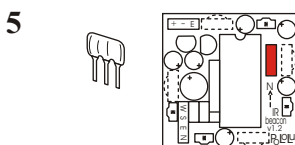

Mount the 4MHz resonator, X1, on the **TOP** side of the board. The resonator is a symmetrical device that can be mounted in two orientations. It is generally good practice to mount components so that their markings are as visible as possible, so the resonator should be mounted so that the markings on its side face out from the board (away from U1).

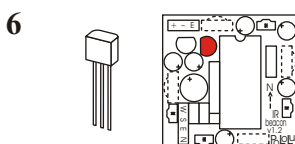

Now, add the N-channel FET, Q1, from the **TOP** of the PCB. **The FET is similar to the voltage regulator, U2, but Q1 is slightly smaller.** Bend the middle pin back slightly, and **make sure the more rounded side of the device is directed toward U1**, as indicated on the PCB silkscreen. This FET provides the high-current drive necessary to flash the IR LEDs very brightly.

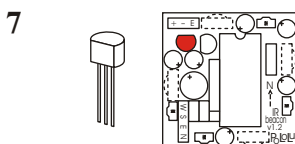

Next, insert U2, the 5-volt voltage regulator, from the **TOP** of the board. Again, bend the middle lead back, and make sure the device is oriented as indicated on the silkscreen drawing. (If you have 5 volts available in your application, U2 can be left out and the 5 volts can be connected to the hole closest to the 'U2' marking. Your 5-volt source should be capable of providing at least 15 mA.)

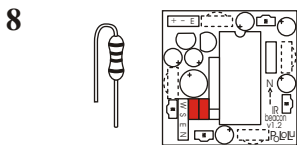

Insert the two resistors from the **TOP** of the PCB. To make them fit into their holes, bend the leads as shown. These resistors set the brightness of the IR LEDs. Lowering the resistance will increase the beacon range; increasing the resistance will lower the range but lower power consumption. Both resistors should have the same value. Using the provided 15-ohm resistors should result in at least a 10-foot range.

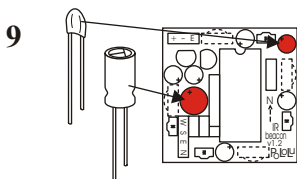

Next, insert the capacitors from the **TOP** of the board. **Both capacitors are polarized, so make sure to insert them correctly.** The longer leads are generally the positive leads, and the positive holes are marked on the PCB. The cylindrical C1 (electrolytic) has a stripe on the can indicating the negative lead. The smaller C2 (tantalum) has the positive lead marked with a small '+’.

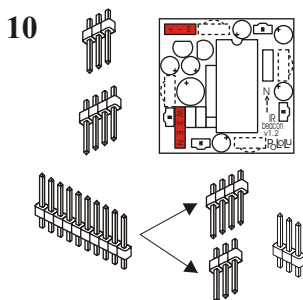

In this step, add the beacon connectors from the **BOTTOM** of the PCB. Break apart the 10-pin header strip so that you have one 3-pin strip and one 4-pin strip. You can either cut the pins apart with diagonal cutters or snap the strip using two pairs of pliers (if you just use one pair of pliers or use your hands, you might not be able to control the location of the snap). The extra three pins are not used. CON1 is for power and enable inputs; CON2 has the four beacon outputs.

The connectors are optional, and you are free to solder wire directly onto the PCB or to use your own connectors. In any case, the connections should go into the bottom side of the PCB since the beacon should be mounted at the highest point on your robot.

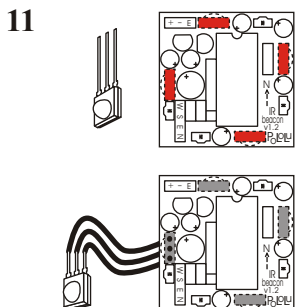

Next, mount the IR detector modules, U3-U6, from the **BOTTOM** of the PCB. **The round lens on the modules should face out from the center of the PCB, as indicated by the arcs on the PCB silkscreen.**

You may choose to solder wires onto the detector modules and then solder the wires into the PCB, allowing the detectors to be positioned freely at other angles than the ones set by the PCB. For example, placing all detectors on one side of your robot would sacrifice 360° coverage but provide better resolution. If the detectors are positioned in similar directions, opaque shielding around each detector can improve performance. Of course, the detector-output correspondence will not change; for example, the W output will always correspond to the detector connected to the west side of the PCB.

12

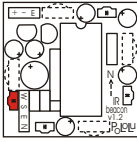

Now, add the last IR LED, D4, onto the **TOP** of the PCB. As with the other three LEDs, **the lens must face OUT** from the center of the board, and when viewed face-on from the side of the PCB, the package should appear as indicated in the drawing to the right.

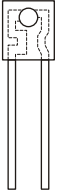

13

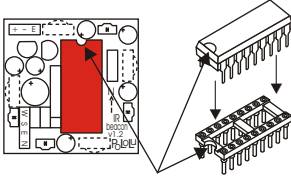

Finally, insert the PIC microcontroller into its socket. **The package has a notch that you must match up with the notch on the PCB silkscreen.** If you are ready to mount the beacon onto your robot and you wish to use the two mounting holes under the PIC, you should insert the PIC after mounting the PCB.

Mounting and Connecting the Beacon

You should mount the beacon at the highest point on your robot so that parts of your robot do not block light coming to and from the beacon. A simple approach is to mount the beacon on a wooden dowel connected to your robot. The beacon can be mounted with double-sided tape or hot glue. The PCB has two 0.125" holes under U1 that can be used for more elegant mounting. The spacing between the holes is 1/2", and there is no electrical connection to the mounting holes. The primary restriction on using the mounting holes is that the screw heads must fit inside the gaps in the socket.

There are two connectors on the beacon: CON1 has the power and enable inputs, and CON2 has the outputs. The left two pins on CON1 are for connecting power; the left pin is the positive supply, and the middle pin is ground. **You can permanently damage your beacon by applying power incorrectly, so be careful!** The supply voltage must be in the range 5.1-10.0 volts. The average current consumption is about 50 mA, but the exact amount depends on the values for R1 and R2, whether or not the indicator LEDs are used, and the supply voltage. The enable input is optional as it is pulled high by default. To turn off transmission, set the enable line low, and the beacon will go into a low-power mode and flash the green LED to indicate that it is turned on but disabled. **CON2 has the four outputs, which are normally high and go low to indicate detection.**

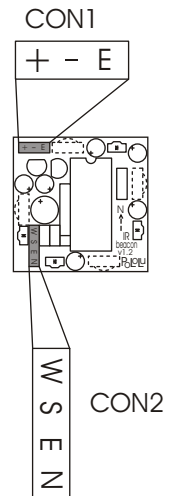

Testing Your Beacon

Once you assemble the beacon, the easiest way to check your work is to connect 5.1-10.0 volts to the '+' and '-' pins, with the enable pin disconnected (or set high). When power is applied, all of the red LEDs should turn on in the order, N, E, S, W, then turn off in the same order, and then the green LED should begin flickering as the beacon begins transmitting. If you have another beacon, turn it on, and the red LEDs on each beacon should turn on in the direction of the other beacon. If you turn the beacons around, the LEDs should keep lighting up in the direction of the other beacon (make sure you don't cover the detector modules or emitters with your fingers). If your beacon functions as described, it is most likely assembled correctly, and you are ready to use it on your robot. One last check you may want to perform is to make sure the beacon stops transmitting when the enable line is set low (the green LED should switch from a rapid flicker to a slow flash, and the outputs should remain high, with all LEDs off).

If your beacon does not work at first, check the troubleshooting tips.

How the Beacon Works

You might be interested in how the beacon works, and understanding its operation should help you with any necessary troubleshooting. A schematic diagram of the beacon is provided below.

As you can see, U1 is the central component to which all other components are connected. U1 is a PIC microcontroller, which is a small computer that executes one million instructions per second. X1 is a ceramic resonator that oscillates at 4 MHz and sets the PIC execution speed. The four IR detectors, U3-U6, are powered off of two PIC pins (RA0 and RA1) so that the detectors can be powered down when the beacon is disabled. The power pins on the detectors are connected so that all detectors

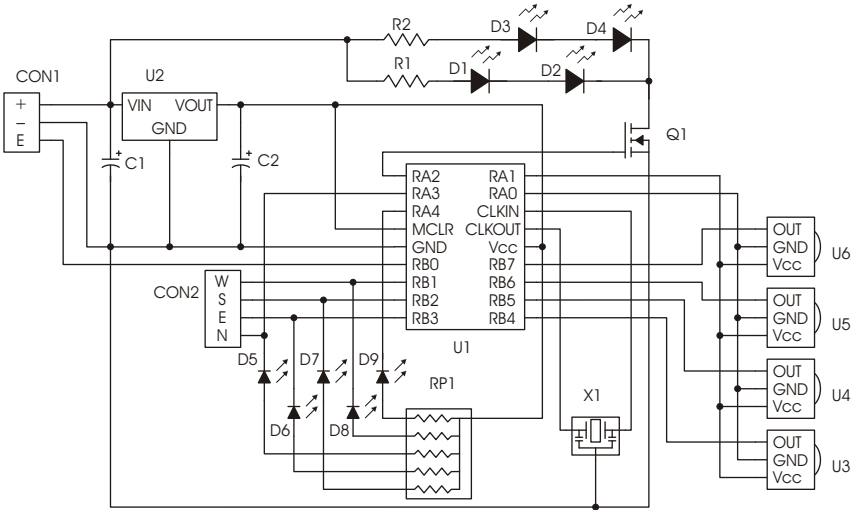

How the Beacon Works (continued)

are turned on and off together, but each of the detector module output pins are connected to separate PIC pins. Output pin RA2 controls FET Q1, which turns the infrared LEDs (D1-D4) on and off. The FET is used because a large current flows through the IR LEDs (the PIC outputs are made of FETs, but those FETs are much smaller and cannot provide the necessary current). R1 and R2 control the current going through the IR LEDs and thereby control the beacon's brightness. The resistor pack, RP1, is a compact way of packaging the five resistors used to limit the visible LED (D5-D9) currents. The four red LEDs are just connected to the four beacon outputs, but the green LED has its own PIC line (RA4). Therefore, the green LED is not physically linked to any of the beacon's other functions, but the PIC uses it to provide you with some indication of whether the beacon is enabled or not. U2 regulates the input voltage to the 5 volts necessary for the PIC. C2 is necessary for the regulator output to be stable, and C1 limits noise on the input power line.

The electrical connections on the beacon are simple because the program running on the PIC does all of the hard work. When the power comes on, the PIC first checks its enable line to see whether the beacon should begin operating. If the enable line is high, the PIC checks the detector module inputs to determine whether or not they are installed properly. If the detectors are not detected, the PIC flashes the corresponding LEDs (by toggling the outputs) and from that point on ignores the bad inputs. After that point, the program enters a loop in which every 50 ms (20 times per second), a series of IR pulses are sent and the IR detectors are sampled. If the detectors are responding above an appropriate threshold, the most responsive detector direction is determined, and the outputs are updated. The beacon never responds to reflections of its own IR emitters because the PIC can turn off the detector modules while it is transmitting. To limit sensitivity to ambient light, the pulses that the beacon emits have a 56 kHz envelope to which the detectors are tuned. Similar modules are used for remote control of household appliances, so your beacon may respond to some handheld remote controls.



Troubleshooting Tips

None of the LEDs ever turn on

There is apparently a significant problem with your beacon, and there could be several reasons for none of the LEDs turning on. First, make sure you are applying a correct voltage and polarity to the power pins. Next, verify that all of your LEDs are soldered in correctly. When you look at the PCB from the side, the metal inside the plastic dome of the LED should appear as indicated in the drawing to the right. Also, make sure the resistor pack RP1 is installed (see assembly step 2). Next, check that the notch on U1 matches the notch on the PCB silkscreen. Also, make sure that the voltage regulator, U2, and the capacitors are installed correctly. A last thing to verify visually is the solder connections: make sure there are no shorts between adjacent pins and all solder joints are shiny.

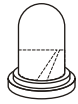

If everything looks correct and the LEDs still don't come on, you will need a multimeter to do more troubleshooting. Begin by disconnecting power and checking continuity between the power inputs to check for a short circuit on the board. Also, check for a short between regulated power and ground (this can easily be done across C2). If there is a short, use your meter and the schematic diagram to find it and fix it. Next, using the schematic diagram, verify that all of the proper connections are made. If everything looks correct but your beacon still doesn't work, connect power to the board and make sure that you have 5 volts across C2. If not, the voltage regulator may have to be replaced. Otherwise, remove U1 (disconnect power first) and connect a wire between the ground and any of the output pins on CON2. The corresponding red LED should turn on; if it doesn't, the LED may need to be replaced; if the LEDs turn on, then U1 or X1 may need to be replaced.

Some of the LEDs never turn on

Remove U1 from its socket, apply power, and connect a wire between ground and the CON2 output pin corresponding to the LED that does not turn on. If the LED does not turn on, it might be installed incorrectly or damaged. If the LED does turn on, then make sure that there is a connection between the LED and the corresponding PIC pin (see the schematic on the previous page). If the connection is good, U1 or X1 may need to be replaced.

After the red LEDs turn on and off, some of the red LEDs flash four times

A red LED flashing on power-up means that the corresponding IR detector was not found. The IR detectors are supposed to be mounted on the bottom of the board, with the round lens facing out from the board. Check the connections between the detector and PIC, especially if the detectors are not mounted on the board. If everything looks correct, the detector may need to be replaced. However, the beacon will continue regular operation without the detector (the corresponding output will just never be activated).

Troubleshooting Tips (continued)

The red LEDs do not turn on, and the green LED flashes slowly

The enable line is probably low. If the beacon is disabled when it is turned on, the start-up check is skipped. The beacon should begin normal operation (without the start-up check) when the enable line is set high.

My beacon is not detected by other beacons

The infrared LEDs, resistors R1 and R2, or the FET Q1 is probably not installed correctly. The IR LEDs must face out from the PCB, on the top side of the PCB. Check all connections on the PCB using the schematic on the previous page. The resistors R1 and R2 should be in the 15-150 ohm range. If the beacon is not detected at all, the FET may be damaged; if the beacon is not detected only in some orientations, the LED on that side may be damaged.

The red LEDs keep flashing in the startup pattern (or part of the startup pattern)

What is probably happening is that the PIC microcontroller begins operation, but keeps resetting because of intermittent breaks in its power supply. The voltage regulator, U2, is probably damaged, most likely from power having been applied incorrectly. It is also possible that your power source cannot provide the necessary power to run the beacon: when the startup pattern is completed and the IR transmission begins, the power consumption jumps suddenly; if the power supply is weak, the voltage drops and the microcontroller resets. Keep in mind that the average power consumption is about 50 mA, but there is a wide range of instantaneous consumption as the IR LEDs turn on and off. Your power supply should be able to provide short bursts of up to 500 mA (which shouldn't be a problem with most batteries). If you are using a power source other than a battery, it might help to put a large capacitor (several hundred microfarads) across the power input to the beacon.

My beacon detects another beacon when there isn't another one in sight

The light from another beacon can bounce around corners, so it is possible that there is another beacon in range. In rare cases, some fluorescent lights, TV remote controls, auto-focus cameras, and other sources of infrared light can interfere with the beacon.

My beacon seems confused when it is close to another beacon

The beacon may begin performing inconsistently once it is within approximately one foot of another beacon. To improve its performance at close range, you can add opaque shielding around the IR detector modules so that they can see only in the direction they are facing. You can also increase the values of resistors R1 and R2 (on all beacons involved), but this will also decrease the maximum detection range.

We understand that working with IR can be frustrating because you cannot see whether an LED is transmitting or not. If your beacon still does not work, check the Pololu web page at <http://www.pololu.com/> to check for any updates and answers to common problems. You can also contact us through the online feedback form or email us at support@pololu.com.



The Pololu IR Beacon

The Pololu IR beacon is a small device that allows pairs of robots to detect each other. The beacon operates by transmitting and detecting modulated infrared light. The beacon provides four outputs, which correspond to the four cardinal directions. When another beacon is detected, the output for the appropriate direction is activated. This simple interface allows even the most basic robot controller to connect to the beacon. An enable input allows the beacon to shut down transmission and enter a low-power mode.

The Pololu beacon is ideal for robot contests and other applications in which small autonomous robots interact.

Specifications

PCB size.....	1.3" x 1.3"
IR modulation frequency.....	56 kHz
Output refresh rate.....	20 Hz
Detection range.....	6 inches to 20 feet
Supply voltage.....	5.1-10 V
I/O voltage.....	0 and 5 V
Number of IR detectors.....	4
Components in kit.....	25 (including PCB)
Current consumption.....	50 mA (average)

